

# **Instruction Manual**

**FOR**

**Benchtop High Speed Refrigerated Centrifuge**

**TGL-18**

Thanks for using Sichuan SHUKE Centrifuge.

In order to play the best performance and security, please read this instruction carefully before you installing, using or maintaining this instrument.

# Contents

1. Safety Cautions .....	4
1.1 Installation and maintenance .....	4
1.2 Electric protection.....	4
1.3 Fire prevention.....	4
1.4 Operation security.....	5
1.5 Chemistry & Biology notice.....	5
2. Symbols & its meanings.....	5
3. Product introduction.....	6
3.1 Product use and application scope.....	6
3.2. Product features.....	6
3.3. Working principle.....	6
4. Technical parameters.....	6
4.1 Centrifuge parameters.....	6
4.2 Rotor parameters.....	7
5. Install & Debug.....	7
5.1 Remove the package.....	7
5.2 Installation requirements.....	7
5.3 Installing .....	8
5.4 Debug requirements.....	9
6. Operation.....	9
6.1 Button instruction of panel .....	9
6.2 Parameters setting.....	10
6.3 Acceleration and deceleration setting.....	10
6.4 Program store.....	10
6.5 Program recall.....	11
6.6 Start.....	11
6.7 Stop.....	11
6.8 Troubleshooting.....	12
7, Maintenance & Repair notice.....	13

7.1 Maintenance notice .....	13
7.2 Repair notice.....	14
8, Transportation and storage.....	15
8.1 Transportation.....	15
8.2 Storage.....	15
9. Warranty regulations .....	15

Enclosed documents: **Certificate of compliance; product warranty card; packing list, diagram of installing rotor.**

## 1. Safety Cautions:

**Safety Cautions:** safety caution is aimed at the safety operation of the centrifuge which is described in this instruction. In the interest of your own personal safety, Please read it carefully before you install, operate, maintain and repair this centrifuge. Knowing this safety caution and proper operating skills, the operator can avoid the hurting as well as avoid the damage to the centrifuge.

### 1.1 Installation and maintenance

- The centrifugal chamber may contain rotors and other accessories in it, please open the lid to check and get out of it before installing.
- When maintaining this centrifuge, all the parts which needed to remove the cover may cause electric injury. Make sure you have cut off the electricity and pulled the plug from the socket when maintaining this instrument. The maintaining work should be done by professional staffs.
- The replacement parts should be confirmed to conform to the demand of this centrifuge.

**To avoid damage to the compressor caused by incorrect transportation, wait four hours after installation before switching on the device.**

**To disconnect the mains supply from the centrifuge in the event of errors occurring, an emergency switch which is separate from the centrifuge must be available, this switch should be outside the room in which the centrifuge is operated or next to the exit of the room**

### 1.2 Electric protection

- To reduce the danger risk of the electric shocks, this centrifuge adopts three core plugs, which must connect with three core socket which connects with ground wire.
- Make sure the socket on the wall connects well with the ground wire. Make sure the power voltage must conform to the voltage this centrifuge uses.
- DO NOT use three-hole changing to two-hole expansion power adapter.
- DO NOT use two wire expansion socket or multi-use power adapter which is not connect with the ground wire.
- DO NOT put the container which is full of liquid on or near the centrifuge. If the container is knocked over, the liquid may penetrate into the centrifuge, which would destroy the components.

### 1.3 Fire prevention.

- Please use the same type specification overload insurance fuse. This machine use the type specification for the fuse is BGXP  $\phi 5 \times 20$  250V 15A.
- This centrifuge is not designed for separating flammable and explosive materials. **DO NOT** use this centrifuge to centrifuge these materials, **DO NOT** put these kinds of materials in the centrifuge, or put such material in all the surrounding distance

within 30cm range.

#### 1.4 Operation security

- Please use our company's rotors and accessories which designed for this centrifuge.
- Please make sure the centrifugal chamber is clear and no sundries before you start it.
- **The rotor and the rotor cover must always be securely fastened.**  
**Do not begin centrifugation before the rotor has been securely fastened.**
- Please make sure the speed of the rotor does not exceed its max speed when it at work.
- Please do not use your hand to force the rotor to decelerate or stop.
- Please do not lift or move the centrifuge before the rotor stop rotate
- Please don't open the lid when the centrifuge is at work.
- **Please don't** switch on and switch off the power frequently otherwise the compressor will be blocked.
- When the centrifuge is working, make sure there is no other objects was putted surround the centrifuge within the distance of 30 cm. Please don't work in that range, except you need to debug the machine. DO NOT stretch anything into the centrifuge when it at work.
- **Strictly prohibited the centrifuge running without rotor, otherwise chuck cracking will occur.**

#### 1.5 Chemistry & Biology notice



- Routine operation may include all kinds of solution and test samples which may be pathogenic, toxic or radioactive material, all the materials should not be centrifuged by this centrifuge, unless protective measures have been adopted.
- Please pay attention to the description of the solution on the original solution container before you are going to centrifuge it.
- Be careful when you holding the liquid because they are contagious.
- The operator should strictly obey the operating procedure and method of the laboratory strictly when they operating the centrifuge.
- All the waste solution must be destroyed according to the safety and protection demand of the environment.

When you ask for after-sale service, please make sure you have cleaned up the centrifuge, which is your responsibility.

## 2. Symbols & its meanings

Chart 1

No.	CODE	GB No.	MEANING
1	~	4706.1	AC POWER

2		5465.2	CONNECT POWER
3	○	5465.2	OFF POWER
4		4728.2	CONNECT TO THE GROUNDED (EARTH)
5		4793	CAUTION!

### 3. Product introduction

#### 3.1 Product use and application scope

TGL-18 benchtop high speed refrigerated centrifuge (hereinafter referred to as the machine), is widely used in biology, medicine, genetics, agricultural science, food hygiene, environmental protection and other research and manufacturing institutions, it is a ideal instruments and equipment in the colleges and universities, research institutes, blood center, biological pharmaceutical enterprise .

#### 3.2 Product features

This machine adopts variable frequency motor, micro-processor control, LCD and LED display and other advanced technology, the adjustment of the speed adopts the PMW control method, it can store 12 memories and there are 19 levels of acceleration and deceleration for your choice.

The feature is below:

- (1) Due to the unique of shock absorber and the special design, the anti-vibration effect is good.
- (2) The control system of the speed adopts PID control way, it's with a high precision, different level of acceleration and deceleration selectable, 19level in total. The variable frequency motor makes the machine working peacefully, brushless and no carbon dust pollution.
- (3) Automatic calculation RCF value; has the function of short spin.
- (4) Electronic locks system security the centrifuge work safely. the centrifuge can't work when the door does not lock.

#### 3.3. Working principle

The centrifuge is a machine using the powerful centrifugal force which was produced by the high speed spin of the rotor to accelerate the settlement of particles in the liquid, make the samples of different subsidence coefficient and different density of the substance separate, concrete and pure.

### 4. Technical parameters

#### 4.1 Centrifuge parameters.

Max Speed	18000 r/min
Max RCF	22500 xg
Max Capacity	6x1000ml(9000rpm)
Speed Accuracy	±10 r/min
Temp Accuracy	±1℃
Temp Range	-20℃~40℃
Timer Range	1min~99H59 min/inching
Noise	≤60 dB (A)
Power Supply	AC 220V 50HZ 15A
Dimension	420x625x360 (LxWxH) mm
Weight	55 kg

## 4.2 Rotor parameters

Rotor	Capacity	Max Speed	Max RCF
NO.1 Fixed-angle Rotor	12x1.5/2.2ml	18000rpm	22500xg
NO. 2 Fixed-angle Rotor	12x5ml	15000rpm	18270xg
NO. 3 Fixed-angle Rotor	24x1.5/2.2ml	13000rpm	15620xg
NO. 4-1 Fixed-angle Rotor	12x10ml	13000rpm	15620xg
NO. 4-2 Fixed-angle Rotor	36x1.5ml/2.2ml		
NO. 5-1 Fixed-angle Rotor	6x50ml conical bottom	12000rpm	15970xg
NO. 5-1 Fixed-angle Rotor	6x50ml round bottom		
NO. 5-2 Fixed-angle Rotor	48x1.5ml/2.2ml		
NO. 6-1 Fixed-angle Rotor	4x100ml	11000rpm	12870xg
NO. 6-2 Fixed-angle Rotor	8x50ml round bottom		
NO. 6-2 Fixed-angle Rotor	8x50ml conical bottom		
No.6-3 Fixed-angle Rotor	12x15ml		

## 5. Install & Debug

### 5.1 Remove the package (by the user)

Users should check the package appearance when receiving the product. Severe impact, accumbency and upend etc. should not happen during transportation. The package appearance should be well. If the situation presented happens, please contact with the cargo agent and inform our company in time.

First, remove the top cover of the package, get out of the rotor and accessories; second, get out of the centrifuge from the package. Last, properly deal with the package and packing, not to pollute the environment, or save these for possible future transport of the centrifuge.

### 5.2 Installation requirements

#### (1) Environment requirements

This machine should be installed in the indoors, on a rigid solid table-board. No conductive dust, corrosive or damaging insulating air, and no powerful vibration

source nearby, avoid direct sunlight.

### **(2) Space requirements**

The distance between the back side of this centrifuge and the wall should be no less than 30 cm, in order to ensure the in-out vent of cooling air demand. The room temperature should not exceed 35 °C to ensure the best performance of the centrifuge.

### **(3) Power supply requirements**

The power for this centrifuge is single-phase 220V-240V, 50Hz, 15A. The power should have protective earth wire. Do not use zero line to instead of protective earth wire. If you are not sure about the power you are using, please contact your distributor or local electricity board.

For safety, this centrifuge adopts single-phase three core plug, to ensure good grounding. If your plug can not put into the socket, please contact electrician to change your original socket to ensure the safe action of the single-phase three core plug. Make sure the good grounding of the centrifuge.

**After installing, the four rubber feet on the bottom of the centrifuge should afford uniform stress, otherwise the user should increase block and readjust to demand.**

## **5.3 Installing**

### **(1) Open the door cover.**

Press “Stop & Open” button, after you hear a sound of unlock, lift up the lid.

**Emergency release, there is a line below the front of the machine (on the left side), which is used when power failure or something wrong with the lock. Pull this line, after you hear a sound of unlock, the door will be unlocked, lift the door cover is ok. This emergency release should not be used at ordinary time.**

### **(2) Installing the rotor.**

Examine the rotor before every use, and make sure there is no any crack or corrosion spot on rotor, especially the hanger and the bottom of the carriers. Strictly prohibited use the rotor which has crack or corrosion pit on it, strictly prohibited use the rotor which is out of guarantee period (guarantee period are showed in chart 6 below).

Put the rotor on the spindle, screw the nut tightly by use the spanner equipped.

**When use the aerosol-tight rotor, please make sure the rotor and the rotor cover must always be securely fastened.**

**Do not begin centrifugation before the rotor has been securely fastened.**



Put the test solution in the test tube(for the angle rotor, the test solution should not exceed 75% of the nominal), then weight it by mount pan balance, the weight error of each filled test tube should be  $\leq 1g$ , (when the solution is below 7ml, you just need to make sure it in balance by visual inspection will be ok).

The test tube must be loaded on the rotor in even number, for swing-out rotor, all of the carriers and test tubes must be loaded in. **Strictly prohibited imbalance rotate**. There is serious accident may occur for imbalance running or not weigh the weight carefully, because these carelessness make the rotor stressed asymmetric.

**(3) Closed the lid**

Press the lid down, the lid was locked after you hear a sound.

**(4) Connect the power**

Make sure the power with an earth wire before you start connect the power, then switch on the power button.

**TO avoid damage to the compressor caused by incorrect transportation, wait four hours after installation before switching on the device.**

**5.4 Debug requirements.**

**WARNING: DO NOT start the machine before you cleaning the centrifugal chamber, otherwise you will damage it!**

- Operate the centrifuge like the operating sequence of NO.6 described below, first choose low speed working, then to the high speed gradually. If there is no exception, the debugging is successful.

## 6. Operation

### 6.1 Button Instruction of Panel

There are 12 buttons on the panel in total (Chart 2)

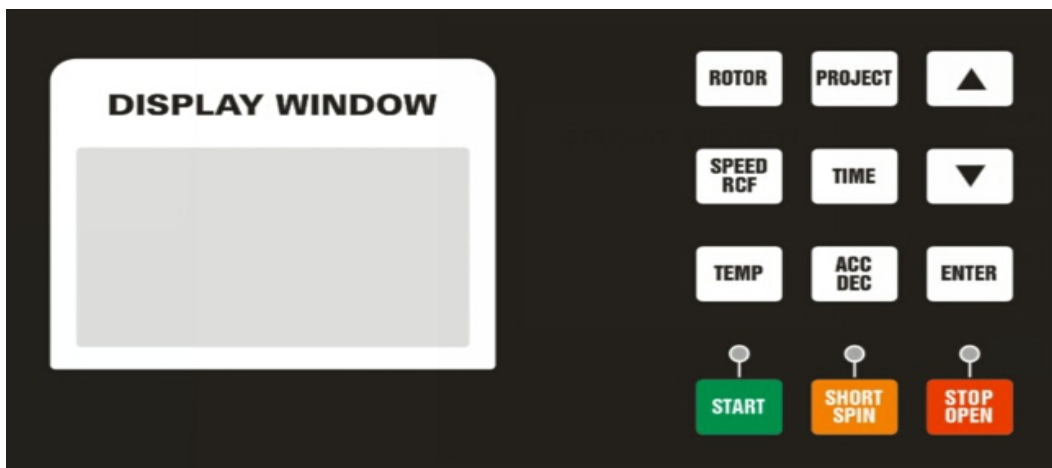

When you press the button, the display window will show the corresponding parameter, then you can press the ▲ or ▼ button to set the parameter, press the “ENTER” button to save it after you finish it.

**For a better observation of the parameter, this centrifuge is LCD and LED displayed, the LCD window displayed the pre-set parameter, the LED displayed the Real-time parameter.**

## 6.2 Parameters setting

There are 12 buttons on the control panel (as mentioned above). When you press the button, the display window will show the corresponding parameter, then you can press the ▲ or ▼ button to set the parameter, press the “ENTER” button to save it. For example, before you start the machine, you need to set the speed. Now press the “SPEED & RCF” button, the window will show the speed value (the RPM and RCF can change freely by press this button), you can press the ▲ or ▼ to set the speed. Such as you want the centrifuge rotate at 8000 rpm, you just press ▲ button, then the speed value will increase, when the value reach 8000 rpm, just stop press the button, press the “ENTER” button to store it, then press the “TIME” button to set the rotate time, press the “ENTER” button to store it, after all the parameters was set, then press the “START” button, the centrifuge will rotate at speed of 8000 rpm. if the Max speed for the rotor is 16000 rpm, you can set the speed you needed between 50 to 16000 rpm (the mini amplitude of the speed is 50 rpm).

**The procedure set is mainly based on the rotate speed. When you want to know the RCF during the operation, press the “SPEED & RCF” key and then the “enter” key to convert it freely.**

## 6.3 Acceleration and deceleration setting

Press ACC/DEC button, when there is letter “A 1” flicker in the display screen, its ACC setting status now, press ▲ or ▼ to adjust the letter, 1 is fastest, 19 is the slowest, 19 levels in total, after you choose it, press the “ENTER” button to store it.

Press ACC/DEC button, when there is letter “D 1” flicker in the display screen, its DEC setting status now, press ▲ or ▼ to adjust the letter, 1 is fastest, 19 is the slowest, 19 levels in total, after you choose it, press the “ENTER” button to store it.

## 6.4 Program store

For a more convenient use, there are 12 program memories storable for repeated routine operation.

Program store: set the parameters first, such as the number of the rotor, rotate speed, time, acceleration, deceleration, etc, then press the “PROJECT” button

twice, there will be letter “C 01” displayed on the screen, press ▲ or ▼ can change the parameters which displayed behind letter “C”, after all is ok, press “ENTER” button to store it. (note: the parameters behind letter “C” is the procedure serial number which you are going to store.)

For example, if you are going to store procedure 01 for rotor NO.1, 16 000 rpm, 20 minutes, ACC levels 4, DEC level 5. Now set the rotor to 1, then press “ENTER” button, set the rotate speed to 16 000, then press the “ENTER” button, set the time to 20 minutes, then press the “ENTER” button, set the ACC to 4, then press the “ENTER” button, set the DEC to 5, then press the “ENTER” button. Press “PROJECT” twice, when there is letter “C 01” displayed on the screen, press ▲ or ▼ button to set the number to “C 04”, then press the “ENTER” button, now the procedure is stored.

### 6.5 Program recall

Press “PROJECT” once when the speed display screen displayed “P 01”, press the ▲ or ▼ button to choose the procedure you needed, then press “ENTER” button to recall this procedure. (note: the number behind the letter “P” is the procedure number you are going to recall.)

### 6.6 Start

After all the parameters were set, press “Start” button, when the green indicator light is on, the centrifuge begins to start. After reaching the given speed, the instrument starts to count down.

 **Please make sure the tube which with solutions in it keeps symmetrical balance before running , the difference can not more than 1g.**

### 6.7 Stop

When it is working, the centrifugal time decelerates to zero; the centrifuge will speed down according to the parameters. When the rotors stop working totally, and hearing the alarm, people can open the lid. If you want to stop the centrifuge during its working, press “Stop & Open” button, the instrument will stop according to the above processes.

**When the centrifuge gives out a fault alarm or showing a code “error”, press the “Stop & Open” key to clear.**

After the centrifuge stop, press “Stop & Open” button, after you hear a sound of unlock, lift up the lid.

## Warning:

 **DO NOT** run rotors overspeed. The user should be responsible for the loss

which is caused by overspeeding. **(The solution in the tube should be exceed 75% of the nominal capacity, The tubes must be placed symmetrical balanced.)**

The operator should discharge the rotor when they need to change it. Loose the lock nut with hexagonal wrenches, then get out of the rotor (**the operator can do this like the enclosed rotor install diagram showed**). To avoid the overspeed spin of the rotor, the relative rotor number must be reset after the rotor was changed, and reset the restriction of the Max speed for the rotor which you are ready to use as well.

 **DO NOT** lift up or move the centrifuge when it is working.

 **DO NOT** open the lid when the rotor is rotating.

## 6.8 Troubleshooting

Chart 3

Error code display	probable causes	solutions
E.2.	The centrifuge lid isn't closed when pressing the start key.	Close the lid tight.
	The installation of the lid testing micro switch doesn't reach the designated position or has been damaged.	Check and change another one
E.1	The motor operates without speed. Speed signal is not reliable, or the speed sensor is damaged.	Check and change another one
	The motor doesn't work. The motor and rotor are locked.	Change motor
	Wires loosen or the powerful electroplax is damaged.	Check and change another one
E.3	The temperature is too high.	Make sure the temp. <40°C
E.4.	Overspeed protection: the rotor number is wrong or the powerful electroplax is not under protection.	Check and change another one
E.5	communication malfunction	Contact manufacturer

**Exclude the above several faults, the machine still can't work normally, please contact with our company or service station.**

## **7. Maintenance & Repair notice**

### **7.1 Maintenance notice**

**(1) Please remove any condensation water in the rotor chamber using a soft, absorbent cloth.**

**Switch off the centrifuge after use, leave the lid open and empty the tray for condensation water, located below the device. The tray is pulled out towards the front**

**For the aerosol-tight rotor, the lid of the aerosol-tight rotor must not be fastened tightly during storage**

Please clean the centrifuge chamber after every use. Put few grease on the shaft of the cone for protection, put some desiccant bag in the centrifuge chamber to avoid shaft corrosion as well.

**(2)** When you are not going to use this machine in the near future or are ready to maintain it, make sure you have pulled the plug from the socket. Because if you just switch off the power button but not pull the plug from the socket, the machine is still with electricity, under this circumstances, the accident may occur, especially when the machine is under maintain.

**(3)** In order to prevent the spindle being bended and damage the drive shaft of the rotor, please be gently when you install or discharge the rotor from the spindle. Screw out the bolt, then taking out the rotor vertically.

**(4)** When you are not going to use this machine in the near future, clean the chamber, dry it. Take out the rotor from centrifugal chamber, clean it with neutral cleaning mixture, dry it with a clean cloth (do not use electric hair drier to dry the rotor), preventing chemical corrosion, put it in a dry and ventilated place. Do not use non-neutral detergent to clean rotor. The center hole of rotor should have a little grease for protection.

**(5)** When using stainless steel tube, the speed should be reduced to a maximum speed of 80% or less to ensure safe use, if Proportion of liquid is greater than 1.2, you need to recalculate the max speed according the following method:

$$N = n\sqrt{1.2/S}$$

(the “N” is the max speed allowed; “n” is the maximum speed of the original; S is the proportion of the centrifugation liquid)

**(6)** The centrifuge tube should be replaced regularly, strictly prohibit to use the tube

which is about to burst.

(7) Polypropylene (PP) tube (bottle) can't come with concentrated nitric acid (95%), aqua regia, toluene, benzene, gasoline, kerosene. Polycarbonate (PC) centrifuge tube (bottle) can't come with hydrofluoric acid, hydrochloric acid (30%, 50%), sulfuric acid (10%), nitric acid nitric acid (95%), aqua regia, potassium hydroxide, magnesium hydroxide, ammonium hydroxide, aluminum fluoride, ammonium sulfide, ammonium acetate, ammonium carbonate, sodium nitrate, chromic acid (50%), toluene, benzene, gasoline, acetaldehyde, acetone, ethanol, isobutanol, ethyl ether, cresol, and others to use together. Polyethylene (PE) centrifuge tube (bottle) can not come with sulfuric acid (50%, 75%), benzene, gasoline, kerosene.

## 7.2 Repair notice

### Fuse replacement

- (1) Turn off the power, disconnect the plug between the wire and external power supply, then disconnect the plug between the wire and centrifuge.
- (2) There is a fuse holder below the power socket on the back side of the centrifuge (chart4), with a fuse symbolic identification, find the V-groove of the fuse holder ( chart5); use a straight screwdriver to insert this groove, and pull out the fuse holder.
- (3) Take out the damaged fuse protector and discard it, take out the standby fuse protector from the holder and install it, the fuse protector specification of this centrifuge is BGXP BGXP  $\phi 5 \times 500$ , 250V, 15A.
- (4) Insert the fuse holder into the power socket.

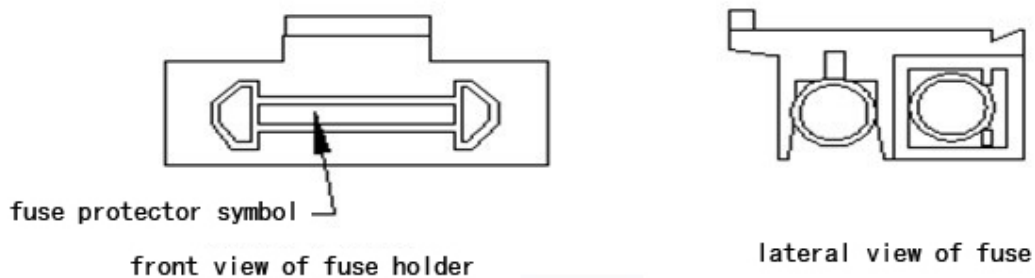

Chart 4

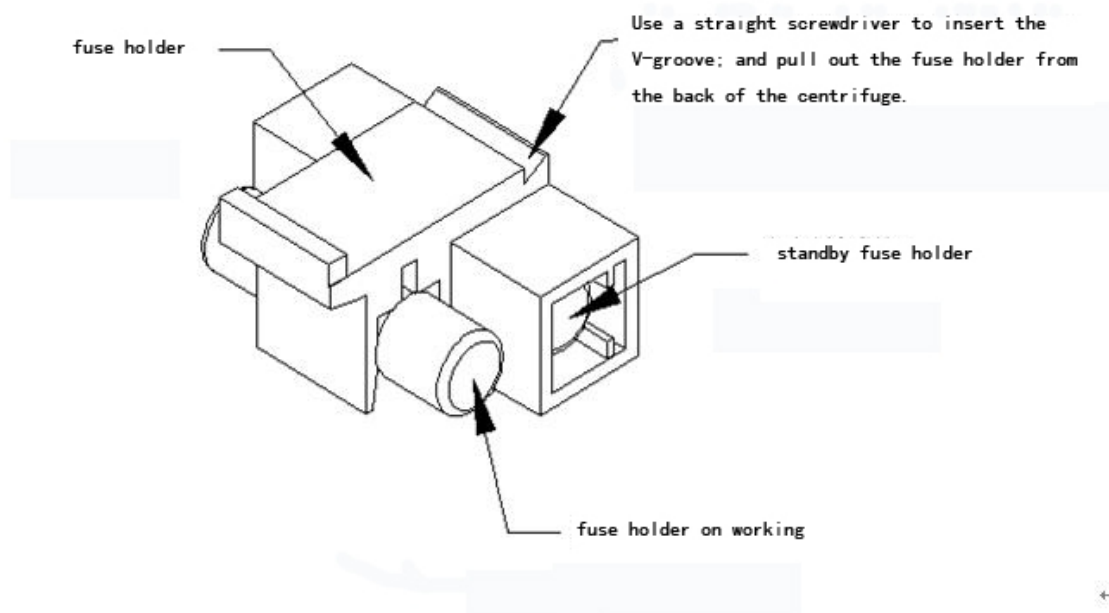

Chart 5

## 8. Transportation and storage

### 8.1 Transportation

- When the centrifuge need a long distance transportation, wooden case should be used. The centrifuge should be cover with dust mask, and fill up with damping materials all around the machine, it is strictly prohibited of collision, rolling and dipping in the rain or snow in the process of the transportation.
- Movement indoor can do directly, but also should avoid big shock, collision, convert.

### 8.2 Storage

- When centrifuge will not put to use for a long period, the lid should be open, store in a ventilated, dry and clean room. The storage place should not have corrosive, inflammable and explosive materials.
- Due to the technology constantly updated, if there is something different with the manual, please contact our company.

## 9. Warranty regulations

All the products of our company, the buyers get one and half year warranty from the today of they bought, we will take all cost because of quality defects during the guarantee period. When there is any problem with the machine at the time which out of the warranty period, we will also provide the maintain service, the users only need to pay the parts cost.

In condition of using correctly, the guarantee period and the service life of the rotor is as showed in the table below:

(chart 6)

Rotor style	Guarantee period	Usage Counter	accumulated use time
Angle rotor	5 years	10000 times	5000 hours
Swing-out rotor	3 years	10000 times	5000 hours

In order to run the rotor safely, the user should record the running status of the rotor carefully, including the solution, rotate speed, time, temperature, and the inspection record, any of that reach the service life above table mentioned, the rotor should be scrap.

Any of the following conditions is not in the free maintenance range

- Failures which caused by incorrect installation, operation or maintenance
- Failures which caused by trying to dismantle, change the relevant components parameters
- Failures which caused by using rotors and accessories not designed for this centrifuge
- Failures which caused by force majeure, such as war, natural disaster, etc.

In order to make people understand our product, and provide better service for customers, please keep the warranty card and maintenance record.



**Certificate of Compliance**  
**for**  
**Benchtop High Speed Refrigerated Centrifuge**  
**TGL-18**

Product Name: Benchtop high speed refrigerated centrifuge

Model No.: TGL-18

Factory Number: 21031113

This product is permitted to leave the factory after inspection.

Inspector: \_\_\_\_\_

Date: \_\_\_\_\_

# Product warranty card

(maintained this card within the warranty period.)

Product Name	Benchtop high speed refrigerated centrifuge		
Model	TGL-18	Product number	XXXX
Date of production	XXXXXX	Purchase date	
Name of user and Department(stamped)			
Address:			Contact:
Tel:	Fax:	E-mail:	
Comments and Suggestions to our products:			

# Packing List

Serial number	Name	Quantity	Unit	Remarks	
1	TGL-18 centrifuge mainframe	1	set		
2	optional rotors	6x50ml angel rotor	1	set	
3		15ml adaptor	1	set	
4					
5					
6	attachment tools	special spanner	1	set	
7		power wire	1	set	
8					
9					
10	attachment documents	instruction manual	1	piece	
11		certificate of compliance	1	piece	
12		product warranty card	1	piece	
13		rotors install diagram	1	piece	
14		packing list	1	piece	
15					
16					
17					

Packing person: \_\_\_\_\_

Date: \_\_\_\_\_