

Instruction Manual

FOR

Benchtop low speed Centrifuge

In order to play the best performance and security, please read this instruction carefully before you installing, using or maintaining this instrument.

Contents

1. Safety Cautions	4
1.1 Installation and maintenance	4
1.2 Electric protection.....	4
1.3 Fire prevention.....	4
1.4 Operation security.....	5
1.5 Chemistry & Biology notice.....	5
2. Symbols & its meanings.....	5
3. Product introduction.....	6
3.1 Product use and application scope.....	6
3.2. Product features.....	6
3.3. Working principle.....	6
4. Technical parameters.....	6
4.1 Centrifuge parameters.....	6
4.2 Rotor parameters.....	7
5. Install & Debug.....	7
5.1 Remove the package.....	7
5.2 Installation requirements.....	7
5.3 Installing	7
5.4 Debug requirements.....	8
6. Operation.....	9
6.1 Button instruction of panel	9
6.2 Parameters setting.....	9
6.3 Start.....	10
6.4 Stop.....	10
6.5 Troubleshooting.....	10
7, Maintenance & Repair notice.....	11
7.1 Maintenance notice	11
7.2 Repair notice.....	12

8, Transportation and storage.....	13
8.1 Transportation.....	13
8.2 Storage.....	14
9. Warranty regulations	14

Enclosed documents: **Certificate of compliance; product warranty card; packing list.**

1. Safety Cautions:

Safety Cautions: safety caution is aimed at the safety operation of the centrifuge which is described in this instruction. In the interest of your own personal safety, please read it carefully before you install, operate, maintain and repair this centrifuge. Knowing this safety caution and proper operating skills, the operator can avoid the hurting as well as avoid the damage to the centrifuge.

1.1 Installation and maintenance

- The centrifugal chamber may contain rotors and other accessories in it, please open the lid to check and get out of it before installing.
- When maintaining this centrifuge, all the parts which needed to remove the cover may cause electric injury. Make sure you have cut off the electricity and pulled the plug from the socket when maintaining this instrument. The maintaining work should be done by professional staffs.
- The replacement parts should be confirmed to conform to the demand of this centrifuge.

To disconnect the mains supply from the centrifuge in the event of errors occurring, an emergency switch which is separate from the centrifuge must be available, this switch should be outside the room in which the centrifuge is operated or next to the exit of the room

1.2 Electric protection

- To reduce the danger risk of the electric shocks, this centrifuge adopts three core plugs, which must connect with three core socket which connects with ground wire.
- Make sure the socket on the wall connects well with the ground wire. Make sure the power voltage must conform to the voltage this centrifuge uses.
- DO NOT use three-hole changing to two-hole expansion power adapter.
- DO NOT use two wire expansion socket or multi-use power adapter which is not connect with the ground wire.
- DO NOT put the container which is full of liquid on or near the centrifuge. If the container is knocked over, the liquid may penetrate into the centrifuge, which would destroy the components.

1.3 Fire prevention.

- Please use the same type specification overload insurance fuse. This machine use the type specification for the fuse is BGXP $\phi 5 \times 20$ 250V 2A.
- This centrifuge is not designed for separating flammable and explosive materials. **DO NOT** use this centrifuge to centrifuge these materials, **DO NOT** put these kinds

of materials in the centrifuge, or put such material in all the surrounding distance within 30cm range.

1.4 Operation security

- Please use our company's rotors and accessories which designed for this centrifuge.
- Please make sure the centrifugal chamber is clear and no sundries before you start it.
- **Do not begin centrifugation before the rotor has been securely fastened.**
- Please make sure the speed of the rotor does not exceed its max speed when it at work.
- Please do not use your hand to force the rotor to decelerate or stop.
- Please do not lift or move the centrifuge before the rotor stop rotate
- Please don't open the lid when the centrifuge is at work.
- When the centrifuge is working, make sure there is no other objects was putted surround the centrifuge within the distance of 30 cm. Please don't work in that range, except you need to debug the machine. DO NOT stretch anything into the centrifuge when it at work.

1.5 Chemistry & Biology notice

- Routine operation may include all kinds of solution and test samples which may be pathogenic, toxic or radioactive material, all the materials should not be centrifuged by this centrifuge, unless protective measures have been adopted.
- Please pay attention to the description of the solution on the original solution container before you are going to centrifuge it.
- Be careful when you holding the liquid because they are contagious.
- The operator should strictly obey the operating procedure and method of the laboratory strictly when they operating the centrifuge.
- All the waste solution must be destroyed according to the safety and protection demand of the environment.

When you ask for after-sale service, please make sure you have cleaned up the centrifuge, which is your responsibility.

2. Symbols & its meanings

Chart 1

No.	CODE	GB No.	MEANING
1	~	4706.1	AC POWER
2		5465.2	CONNECT POWER
3	○	5465.2	OFF POWER
4		4728.2	CONNECT TO THE GROUNDED (EARTH)

5		4793	CAUTION!
---	---	------	----------

3. Product introduction

3.1 Product use and application scope

TD-4K Gel Card Centrifuge is used in blood serum, blood type routine examination, red blood cell washing, micro column gel immunoassay test.

3.2 Product features

TD-4K low-speed centrifuge is the latest product developed by our company's technical specialists. It is also the latest product developed by several domestic and foreign specialized biotechnology companies to conduct market research and trial production. Mainly used in blood group serology microcolumn gel test. Microcomputer processor precise control, touch control panel, easy operation, digital screen displays various operating parameters in real time. This instrument is equipped with special step separation technology. Built-in routine centrifugation work program. Electronic intelligent door lock; brushless inverter motor; equipped with system self-check protection program, safe and reliable, easy to operate, scientific and practical.

The feature is below:

- (1)The efficient program of blood typing and serum test.
- (2)Variable frequency drive motor, microcomputer control.
- (3)It has electronic lid lock device, over-speed safety device, and automatic system check, etc.
- (4)Low noise,without carbon powder pollution.
- (5)Optional with 12 and 24 micro gel rotor.
- (6)Professional program design,it can run directly without parameter settings.

3.3. Working principle

The centrifuge is a machine using the powerful centrifugal force which was produced by the high speed spin of the rotor to accelerate the settlement of particles in the liquid, make the samples of different subsidence coefficient and different density of the substance separate, concrete and pure.

4. Technical parameters

4.1 Centrifuge parameters.

Max Speed	3840 r/min
Max RCF	1790 xg
Max Capacity	12 /24 micro-gel cards rotor
Motor	Variable frequency drive motor
Noise	≤60dB(A)
Power Supply	AC 220V 50HZ 10A
Dimension	375×300×360(L× W × H)mm
Weight	23 kg
Power	100 W

4.2 Program instruction

Centrifuge time	The speed	The RCF
0-2 min	900rpm	100xg
2-5 min	1500rpm	280xg

5. Install & Debug

5.1 Remove the package (by the user)

Users should check the package appearance when receiving the product. Severe impact, accumbency and upend etc. should not happen during transportation. The package appearance should be well. If the situation presented happens, please contact with the cargo agent and inform our company in time.

First, remove the top cover of the package, get out of the rotor and accessories; second, get out of the centrifuge from the package. Last, properly deal with the package and packing, not to pollute the environment, or save these for possible future transport of the centrifuge.

5.2 Installation requirements

(1) Environment requirements

This machine should be installed in the indoors, on a rigid solid table-board. No conductive dust, corrosive or damaging insulating air, and no powerful vibration source nearby, avoid direct sunlight.

(2) Space requirements

The distance between the back side of this centrifuge and the wall should be no less than 30 cm, in order to ensure the in-out vent of cooling air demand. The

room temperature should not exceed 35 °C to ensure the best performance of the centrifuge.

(3) Power supply requirements

The power for this centrifuge is single-phase 220V, 50Hz, 2A. The power should have protective earth wire. Do not use null line to instead of protective earth wire. If you are not sure about the power you are using, please contact our distributor or local electricity board.

For safety, this centrifuge adopts single-phase three core plug, to ensure good grounding. If your plug can not put into the socket, please contact electrician to change your original socket to ensure the safe action of the single-phase three core plug. Make sure the good grounding of the centrifuge.

After installing, the four rubber feet on the bottom of the centrifuge should afford uniform stress, otherwise the user should increase block and readjust to demand.

5.3 Installing

(1) Open the lid.

Press “Stop & Open” button, after you hear a sound of unlock, lift up the lid.

Emergency release, there is a line below the front of the machine (on the left side), which is used when power failure or something wrong with the lock. Pull this line, after you hear a sound of unlock, the door will be unlocked, lift the door cover is ok. This emergency release should not be used at ordinary time.

(2) Installing the rotor.

Examine the rotor before every use, and make sure there is no any crack or corrosion spot on rotor, especially the hanger and the bottom of the carriers. Strictly prohibited use the rotor which has crack or corrosion pit on it, strictly prohibited use the rotor which is out of guarantee period (guarantee period are showed in chart 6 below).

Put the rotor on the spindle, screw the nut tightly by use the spanner equipped.

Do not begin centrifugation before the rotor has been securely fastened.

Put the test solution in the test tube(for the angle rotor, the test solution should not exceed 75% of the nominal), then weight it by mount pan balance, the weight error of each filled test tube should be $\leq 1g$, (when the solution is below 7ml, you just need to make sure it in balance by visual inspection will be ok).

For the angle rotor, the test tube must be loaded on the rotor in even number to make sure the rotor can spin in a balance state. **For swing-out rotor, all of the carriers must be loaded in** and the test tube must be load in even number to make sure the rotor can spin in a balance state. **Strictly prohibited imbalance rotate.** There is serious accident may occur for imbalance running or not weigh the weight carefully, because these carelessness make the rotor stressed asymmetric.

Closed the lid

Press the lid down, the lid was locked after you hear a sound.

(3) Connect the power

Make sure the power with an earth wire before you start connect the power, then switch on the power button.

5.4 Debug requirements.

WARNING: DO NOT start the machine before you cleaning the centrifugal chamber, otherwise you will damage it!

- Operate the centrifuge like the operating sequence of NO.6 described below, first choose low speed working, then to the high speed gradually. If there is no exception, the debugging is successful.

6. Operation

6.1 Button Instruction of Panel

There are 7 buttons on the panel in total (Chart 2)

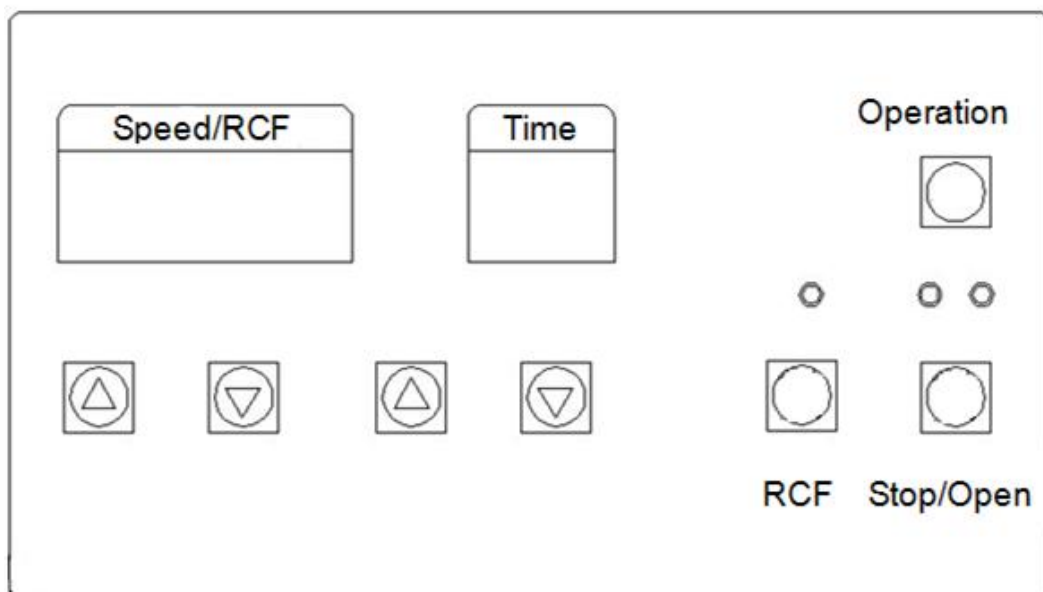

6.2 Parameters setting

There are 7 buttons on the control panel (as mentioned above). When you press the button, the display window will show the corresponding parameter, then you can press the ▲ or ▼ button to set the parameter.

For example, before you start the machine, you need to set the speed. Now press the ▲ or ▼ button which is under the “SPEED & RCF” display column, the window will show the speed value (the RPM and RCF can change freely by press RCF button). Such as when you want the centrifuge rotate at 3000 rpm, you just press ▲ button, then the speed value will increase, when the value reach 3000 rpm, just stop press the button, then press the ▲ or ▼ button which is under the “TIME” display column to set the time, after all the parameters was set, then press the “Operation” button, the centrifuge will rotate at speed of 3000 rpm. if the Max speed for the rotor is 4200 rpm, you can set the speed you needed between 0 to 4200 rpm.

The procedure set is mainly based on the rotate speed. When you want to know the RCF during the operation, press the “RCF” key will be ok.

6.3 Start

After all the parameters were set, press “Operation” button, when the green indicator light is on, the centrifuge begins to start. After reaching the given speed, the instrument starts to count down.

 **The tube which with solutions in it keeps symmetrical balance before running , the difference can not more than 1g.**

6.4 Stop

When it is working, the centrifugal time decelerates to zero; the centrifuge will speed down according to the parameters. When the rotors stop working totally, and hearing the alarm, people can open the lid. If you want to stop the centrifuge during its working, press “Stop & Open” button, the instrument will stop according to the above processes.

When the centrifuge gives out a fault alarm or showing a code “error”, press the “Stop & Open” key to clear.

After the centrifuge stop, press “Stop & Open” button, after you hear a sound of unlock, lift up the lid.

Warning:

 **DO NOT** run rotors overspeed. The user should be responsible for the loss

which is caused by overspeeding. **The tubes must be placed symmetrical balanced.**

The operator should discharge the rotor when they need to change it. Loose the lock nut with the spanner equipped, then get out of the rotor. To avoid the overspeed spin of the rotor, the relative rotor number must be reset after the rotor was changed, and reset the restriction of the Max speed for the rotor which you are ready to use as well.

 **DO NOT** lift up or move the centrifuge when it is working.

 **DO NOT** open the lid when the rotor is rotating.

6.5 Troubleshooting

Chart 3

Error code display	probable causes	solutions
E.3	The centrifuge lid isn't closed when pressing the start key.	Close the lid tight.
	The installation of the lid testing micro switch doesn't reach the designated position or has been damaged.	Check and change another one
E.7	The motor operates without speed. Speed signal is not reliable, or the speed sensor is damaged.	Check and change another one
	The motor doesn't work. The motor and rotor are locked.	Change motor
	Wires loosen or the powerful electroplax is damaged.	Check and change another one
E.6	The temperature is too high.	Make sure the temp. <40°C
E.2	Overspeed protection: the rotor number is wrong or the powerful electroplax is not under protection.	Check and change another one

Exclude the above several faults, the machine still can't work normally, please contact with our company or service station.

7. Maintenance & Repair notice

7.1 Maintenance notice

(1) Please clean the centrifuge chamber after every use. Put few grease on the shaft of the cone for protection, put some desiccant bag in the centrifuge chamber to avoid shaft corrosion as well.

(2) When you are not going to use this machine in the near future or are ready to maintain it, make sure you have pulled the plug from the socket. Because if you just switch off the power button but not pull the plug from the socket, the machine is still with electricity, under this circumstances, the accident may occur, especially when the machine is under maintain.

(3) In order to prevent the spindle being bended and damage the drive shaft of the rotor, please be gently when you install or discharge the rotor from the spindle. Screw out the bolt, then taking out the rotor vertically.

(4) When you are not going to use this machine in the near future, clean the chamber, dry it. Take out the rotor from centrifugal chamber, clean it with neutral cleaning mixture, dry it with a clean cloth (do not use electric hair drier to try the rotor), preventing chemical corrosion, put it in a dry and ventilated place. Do not use non-neutral detergent to clean rotor. The center hole of rotor should have a little grease for protection.

(5) When using stainless steel tube, the speed should be reduced to a maximum speed of 80% or less to ensure safe use, if Proportion of liquid is greater than 1.2, you need to recalculate the max speed according the following method:

$$N = n\sqrt{1.2/S}$$

(the “N” is the max speed allowed; “n” is the maximum speed of the original; S is the proportion of the centrifugation liquid)

(6) The centrifuge tube should be replaced regularly, strictly prohibit to use the tube which is about to burst.

(7) Polypropylene (PP) tube (bottle) can't come with concentrated nitric acid (95%), aqua regia, toluene, benzene, gasoline, kerosene. Polycarbonate (PC) centrifuge tube (bottle) can't come with hydrofluoric acid, hydrochloric acid (30%, 50%), sulfuric acid (10%), nitric acid nitric acid (95%), aqua regia, potassium hydroxide, magnesium

hydroxide, ammonium hydroxide, aluminum fluoride, ammonium sulfide, ammonium acetate, ammonium carbonate, sodium nitrate, chromic acid (50%), toluene, benzene, gasoline, acetaldehyde, acetone, ethanol, isobutanol, ethyl ether, cresol, and others to use together. Polyethylene (PE) centrifuge tube (bottle) can not come with sulfuric acid (50%, 75%), benzene, gasoline, kerosene.

7.2 Repair notice

Fuse replacement

- (1) Turn off the power, disconnect the plug between the wire and external power supply, then disconnect the plug between the wire and centrifuge.
- (2) There is a fuse holder below the power socket on the back side of the centrifuge (chart4), with a fuse symbolic identification, find the V-groove of the fuse holder (chart5); use a straight screwdriver to insert this groove, and pull out the fuse holder.
- (3) Take out the damaged fuse protector and discard it, take out the standby fuse protector from the holder and install it, the fuse protector specification of this centrifuge is BGXP $\phi 5 \times 20$, 250V, 2A.
- (4) Insert the fuse holder into the power socket.

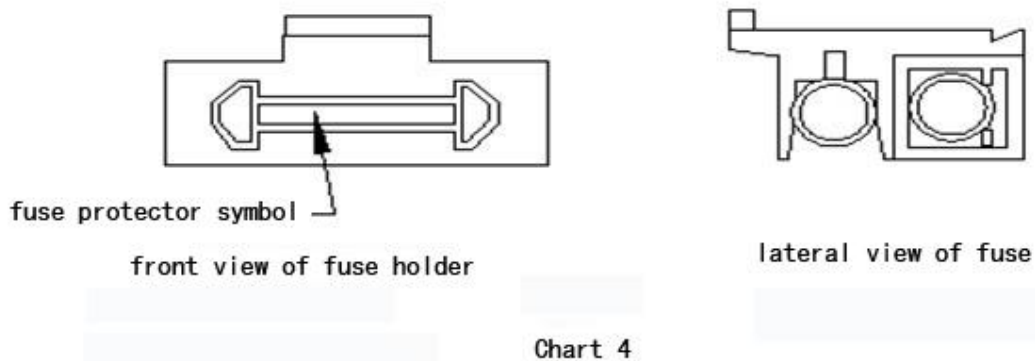

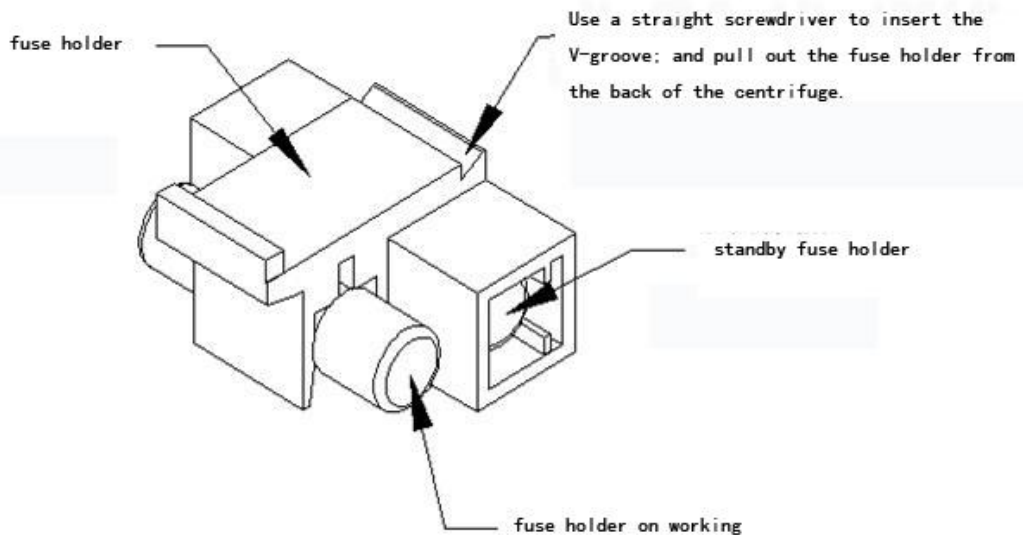

Chart 5

8. Transportation and storage

8.1 Transportation

- When the centrifuge need a long distance transportation, wooden case should be used. The centrifuge should be cover with dust mask, and fill up with damping materials all around the machine, it is strictly prohibited of collision, rolling and dipping in the rain or snow in the process of the transportation.
- Movement indoor can do directly, but also should avoid big shock, collision, convert.

8.2 Storage

- When centrifuge will not put to use for a long period, the lid should be open, store in a ventilated, dry and clean room. The storage place should not have corrosive, inflammable and explosive materials.
- **Due to the technology constantly updated, if there is something different with the manual, please contact our company.**

9. Warranty regulations

All the products of our company, the buyers get one year warranty from the today of they bought, we will take all cost because of quality defects during the guarantee period. When there is any problem with the machine at the time which out of the warranty period, we will also provide the maintain service, the users only need to pay the parts cost.

In condition of using correctly, the guarantee period and the service life of the rotor

is as showed in the table below:

(chart 6)

Rotor style	Guarantee period	Usage Counter	accumulated use time
Angle rotor	2 years	1000 times	2000 hours
Swing-out rotor	2 years	1000 times	2000 hours

In order to run the rotor safely, the user should record the running status of the rotor carefully, including the solution, rotate speed, time, temperature, and the inspection record, any of that reach the service life above table mentioned, the rotor should be scrap.

Any of the following conditions is not in the free maintenance range:

- Failures which caused by incorrect installation, operation or maintenance
- Failures which caused by trying to dismantle, change the relevant components parameters
- Failures which caused by using rotors and accessories not designed for this centrifuge
- Failures which caused by force majeure, such as war, natural disaster, etc.

In order to make people understand our product, and provide better service for customers, please keep the warranty card and maintenance record.

Certificate of Compliance
for
Benchtop Low Speed Centrifuge

Product Name: Benchtop Low Speed Centrifuge

Factory Number:20022702-04

This product is permitted to leave the factory after inspection.

Inspector:_____

Date:_____

Product warranty card

(maintained this card within the warranty period.)

Product Name	Benchtop Low Speed Centrifuge		
Product number	20022702-04	Date of production	Feb.27 ,2020
Purchase date			
Name of user and Department(stamped)			
Address:			Contact:
Tel:	Fax:	E-mail:	
Comments and Suggestions to our products:			

Packing List

Serial number	Name	Quantity	Unit	Remarks
1	centrifuge mainframe	1	set	
2	optional rotors	12 micro-gel cards rotor	1	set
3				
4				
5				
6	attachment accessories and tools	power cord	1	set
7				
8				
9				
10	attachment documents	instruction manual	1	piece
11		certificate of compliance	1	piece
12		product warranty card	1	piece
13		packing list	1	piece
14				
15				
16				
17				

Packing person: _____

Date: _____